

18FF Sockets

RELAY SOCKETS

CE

C  US

File No.: E253370



Features

- The dielectric strength can reach 2000VAC and the insulation resistance is 1000MΩ
- Three mounting types are available: PCB mounting screw mounting and DIN rail mounting.
- With finger protection device
- Many kinds of plug-in modules are available with the function of energizing indication and wiring protection.
- Components available: retainer, marker and plug-in module
- Applicable relay types: HF18FF/HF18FH
- Environmental friendly product (RoHS compliant)

ORDERING INFORMATION

	18FF	-2Z	-C1
Type			
Contact arrangement	2Z: 2 Form C 3Z: 3 Form C 4Z: 4 Form C		
Termination & mounting	A2: PCB terminal, PCB or Screw mounting C1: Screw terminal, DIN rail or Screw mounting, Without finger protection device C2/C4/C5/C8: Screw terminal, DIN rail mounting, With finger protection device C9: Screwless terminal, DIN rail mounting, With finger protection device		

CHARACTERISTICS

Type	Nominal Voltage	Nominal Current	Ambient Temperature	Dielectric Strength min.	Screw Torque	Wire Strip Length	Unit weight
18FF-2Z-A2	250VAC	7A	-40 °C to 70 °C	2000VAC	—	—	Approx.8g
18FF-2Z-C1	250VAC	7A	-40 °C to 70 °C	2000VAC	0.8N · m	7mm	Approx.35g
18FF-2Z-C2	250VAC	7A	-40 °C to 70 °C	2000VAC	0.8N · m	7mm	Approx.36g
18FF-2Z-C4	250VAC	7A	-40 °C to 70 °C	2000VAC	0.6N · m	7mm	Approx.53g
18FF-2Z-C5	250VAC	7A	-40 °C to 70 °C	2000VAC	0.6N · m	7mm	Approx.64g
18FF-2Z-C8	250VAC	7A	-40 °C to 70 °C	2000VAC	0.6N · m	7mm	Approx.41g
18FF-2Z-C9	250VAC	7A	-40 °C to 70 °C	2000VAC	—	7mm	Approx.70g
18FF-3Z-C4	250VAC	7A*	-40 °C to 70 °C	2000VAC	0.6N · m	7mm	Approx.59g
18FF-3Z-C5	250VAC	7A*	-40 °C to 70 °C	2000VAC	0.6N · m	7mm	Approx.71g
18FF-4Z-A2	250VAC	7A*	-40 °C to 70 °C	2000VAC	—	—	Approx.8g
18FF-4Z-C1	250VAC	7A*	-40 °C to 70 °C	2000VAC	0.8N · m	7mm	Approx.58g
18FF-4Z-C2	250VAC	7A*	-40 °C to 70 °C	2000VAC	0.8N · m	7mm	Approx.59g
18FF-4Z-C4	250VAC	7A*	-40 °C to 70 °C	2000VAC	0.6N · m	7mm	Approx.64g
18FF-4Z-C5	250VAC	7A*	-40 °C to 70 °C	2000VAC	0.6N · m	7mm	Approx.76g
18FF-4Z-C8	250VAC	7A*	-40 °C to 70 °C	2000VAC	0.6N · m	7mm	Approx.51g
18FF-4Z-C9	250VAC	7A*	-40 °C to 70 °C	2000VAC	—	7mm	Approx.81g
18FZ-2Z-C2	250VAC	7A	-40 °C to 70 °C	2000VAC	0.8N · m	7mm	Approx.30g
18FZ-4Z-C2	250VAC	5A	-40 °C to 70 °C	2000VAC	0.8N · m	7mm	Approx.44g
18FF-2Z-C1(734)	250VAC	12A	-40 °C to 70 °C	2000VAC	0.8N · m	7mm	Approx.35g
18FF-2Z-C2(734)	250VAC	12A	-40 °C to 70 °C	2000VAC	0.8N · m	7mm	Approx.36g
18FF-2Z-C4(734)	250VAC	12A	-40 °C to 70 °C	2000VAC	0.6N · m	7mm	Approx.53g
18FF-2Z-C5(734)	250VAC	12A	-40 °C to 70 °C	2000VAC	0.6N · m	7mm	Approx.64g
18FF-3Z-C5(734)	250VAC	10A	-40 °C to 70 °C	2000VAC	0.6N · m	7mm	Approx.71g

Remark: For sockets marked *, their group of current totally should be not more than 20A.









HONGFA RELAY

ISO9001, IATF16949, ISO14001, OHSAS18001, IECQ QC 080000 CERTIFIED

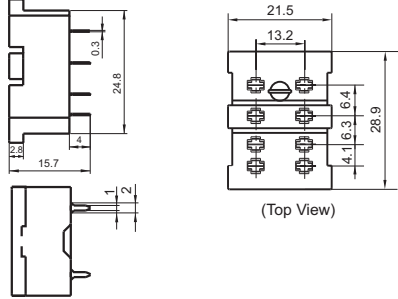
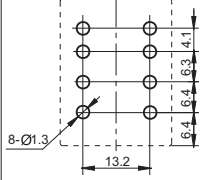
2022 Rev. 1.00

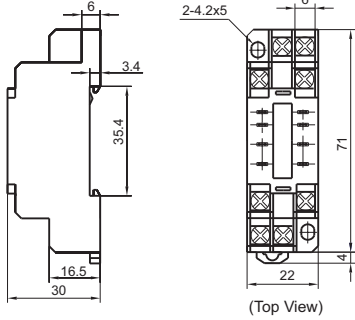
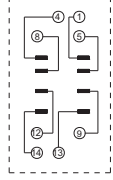
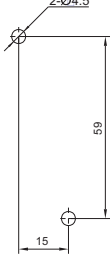

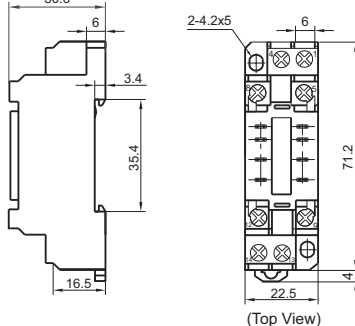
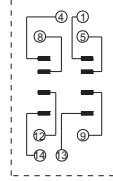
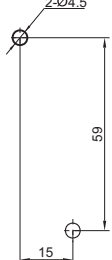

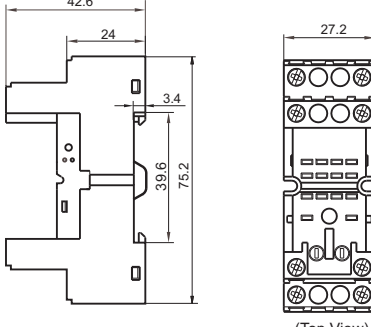
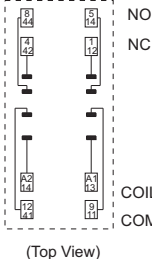
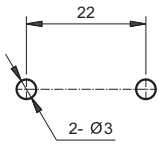

OUTLINE DIMENSIONS, WIRING DIAGRAM AND PC BOARD LAYOUT

Unit: mm

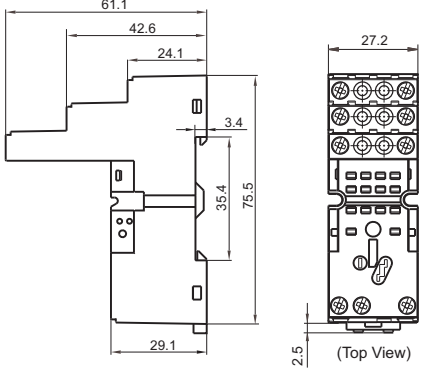
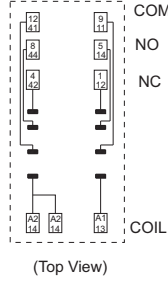
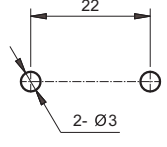
Socket	Outline Dimensions	Wiring Diagram	PCB Layout	Accessory Available
<p>18FF-2Z-A2</p>  <p>PCB Terminal, PCB mounting Applicable for 2 poles</p>	 <p>(Top View)</p>			<p>*metallic retainer 18FF-H1</p>
<p>18FF-2Z-C1 18FF-2Z-C1(734)</p>  <p>Screw Terminal, DIN rail or Screw mounting, Without finger protection device Applicable for 2 poles</p>	 <p>(Top View)</p>	 <p>(Top View)</p>		<p>*metallic retainer 18FF-H2 (be used in sets) 18FF-H3</p>
<p>18FF-2Z-C2 18FF-2Z-C2(734)</p>  <p>Screw Terminal, DIN rail or Screw mounting, With finger protection device Applicable for 2 poles</p>	 <p>(Top View)</p>	 <p>(Top View)</p>		<p>*metallic retainer 18FF-H2 (be used in sets) 18FF-H3</p>
<p>18FF-2Z-C4 18FF-2Z-C4(734)</p>  <p>Screw Terminal, DIN rail or Screw mounting, With finger protection device Applicable for 2 poles</p>	 <p>(Top View)</p>	 <p>(Top View)</p>		<p>*plastic retainer 18FF-H4</p> <p>*metallic retainer 18FF-H5</p> <p>*plug-in module HFAA to HFHU</p> <p>marker 18FF-M1</p>

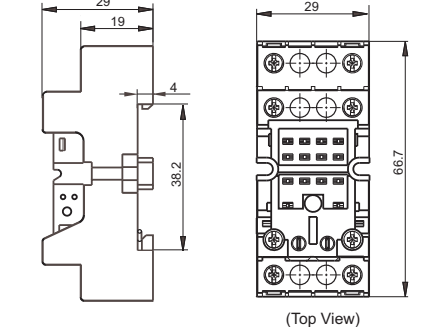
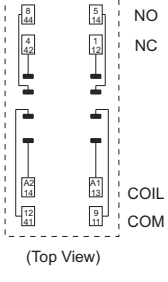
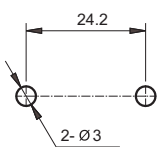

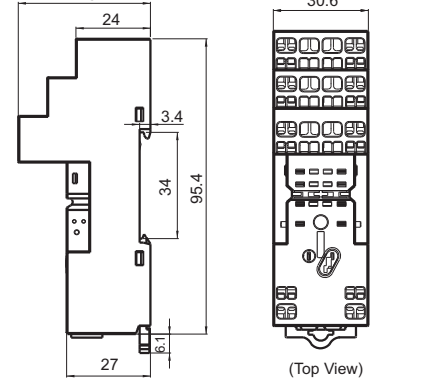
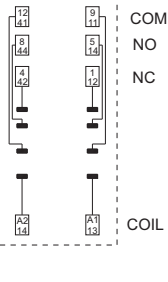

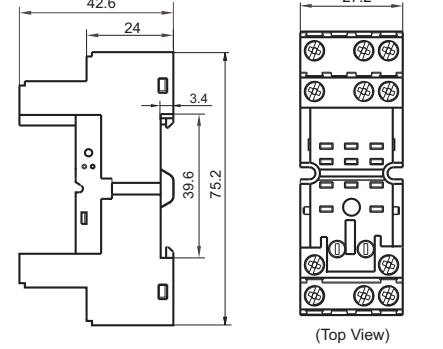
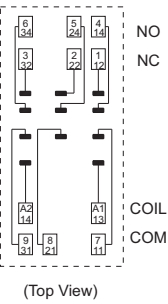
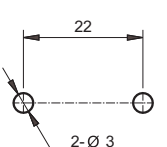

OUTLINE DIMENSIONS, WIRING DIAGRAM AND PC BOARD LAYOUT

Unit: mm

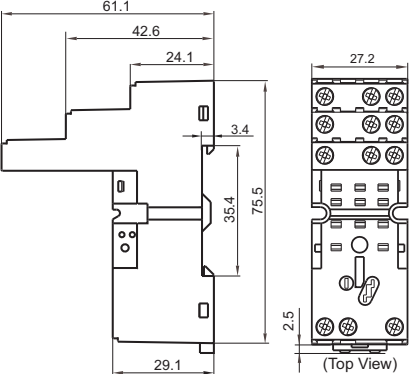
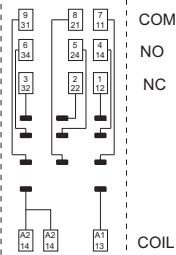
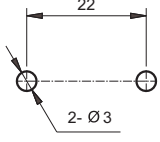
Socket	Outline Dimensions	Wiring Diagram	PCB Layout	Accessory Available
<p>18FF-2Z-C5 18FF-2Z-C5(734)</p>  <p>Screw Terminal, DIN rail or Screw mounting, With finger protection device Applicable for 2 poles</p>	 <p>(Top View)</p>	 <p>(Top View)</p>		<p>*plastic retainer 18FF-H4</p> <p>*metallic retainer 18FF-H5</p> <p>*plug-in module HFAA to HFHU</p> <p>marker 18FF-M1</p>
<p>18FF-2Z-C8</p>  <p>Screw Terminal, DIN rail or Screw mounting, With finger protection device Applicable for 2 poles</p>	 <p>(Top View)</p>	 <p>(Top View)</p>		<p>*metallic retainer 18FF-H5</p> <p>*plastic retainer 18FF-H4</p> <p>*plug-in module HFAA to HFHU</p> <p>marker 18FF-M3</p>
<p>18FF-2Z-C9</p>  <p>Spring-loaded terminal, DIN rail mounting, With finger protection device Applicable for 2 poles</p>	 <p>(Top View)</p>	 <p>(Top View)</p>		<p>*plastic retainer 18FF-H4</p> <p>*metallic retainer 18FF-H5</p> <p>*plug-in module HFAA to HFHU</p> <p>marker 18FF-M3</p>
<p>18FF-3Z-C4</p>  <p>Screw Terminal, DIN rail or Screw mounting, With finger protection device Applicable for 3 poles</p>	 <p>(Top View)</p>	 <p>(Top View)</p>		<p>*plastic retainer 18FF-H4</p> <p>*metallic retainer 18FF-H5</p> <p>*plug-in module HFAA to HFHU</p> <p>marker 18FF-M1</p>

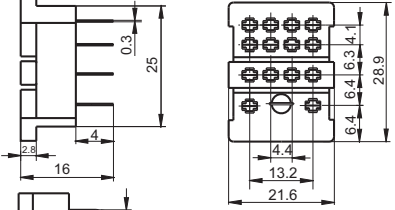
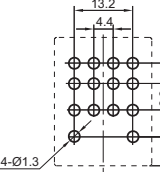

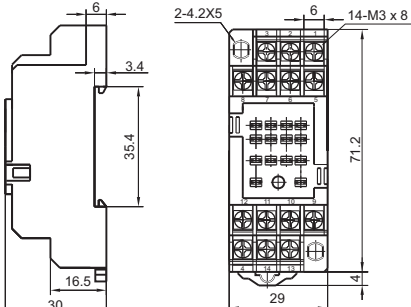
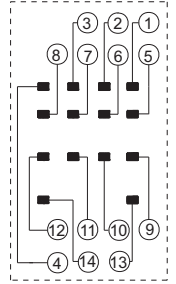
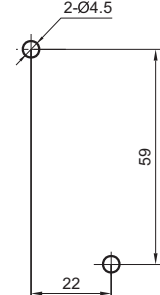

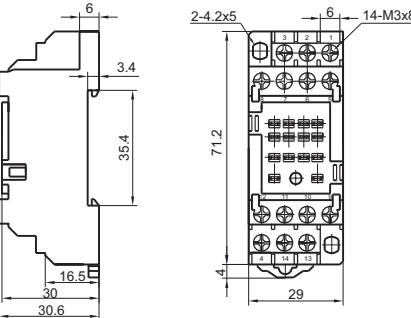
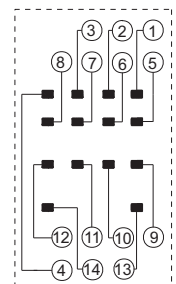
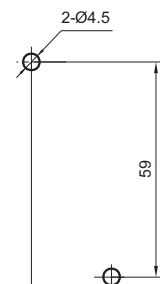

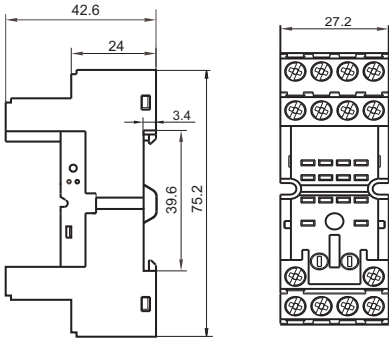
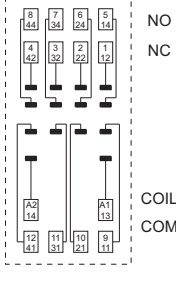
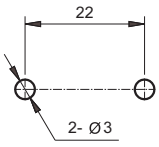

OUTLINE DIMENSIONS, WIRING DIAGRAM AND PC BOARD LAYOUT

Unit: mm

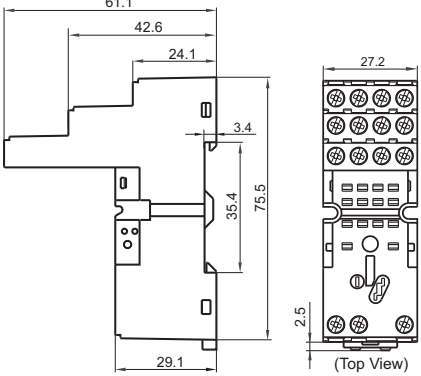
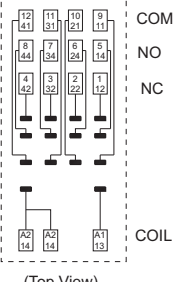
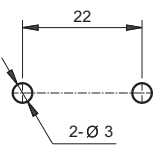
Socket	Outline Dimensions	Wiring Diagram	PCB Layout	Accessory Available
<p>18FF-3Z-C5 18FF-3Z-C5(734)</p>  <p>Screw Terminal, DIN rail or Screw mounting, With finger protection device Applicable for 3 poles</p>	 <p>(Top View)</p>	 <p>(Top View)</p>		<p>*plastic retainer 18FF-H4</p> <p>*metallic retainer 18FF-H5</p> <p>*plug-in module HFAA to HFHU</p> <p>marker 18FF-M1</p>
<p>18FF-4Z-A2</p>  <p>PCB Terminal, PCB mounting Applicable for 4 poles</p>	 <p>(Top View)</p>		 <p>(Top View)</p>	<p>*metallic retainer 18FF-H1</p>
<p>18FF-4Z-C1</p>  <p>Screw Terminal, DIN rail or Screw mounting, Without finger protection device Applicable for 4 poles</p>	 <p>(Top View)</p>	 <p>(Top View)</p>		<p>*metallic retainer 18FF-H2 (be used in sets)</p>
<p>18FF-4Z-C2</p>  <p>Screw Terminal, DIN rail or Screw mounting, With finger protection device Applicable for 4 poles</p>	 <p>(Top View)</p>	 <p>(Top View)</p>		<p>*metallic retainer 18FF-H2 (be used in sets)</p>

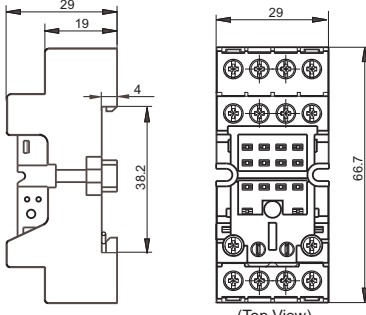
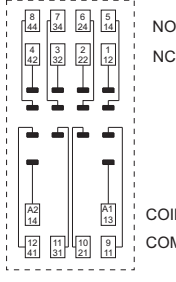
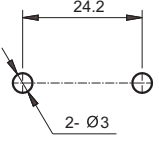
OUTLINE DIMENSIONS, WIRING DIAGRAM AND PC BOARD LAYOUT

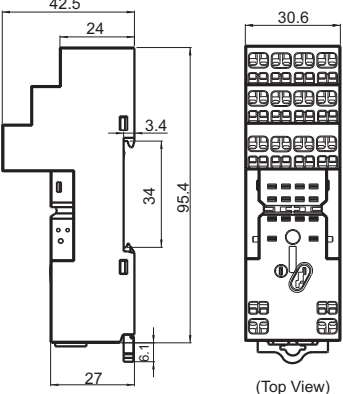
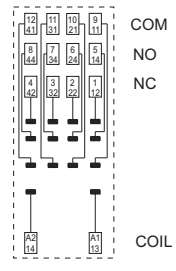

Unit: mm

Socket	Outline Dimensions	Wiring Diagram	PCB Layout	Accessory Available
<p>18FF-4Z-C4</p>  <p>Screw Terminal, DIN rail or Screw mounting, With finger protection device Applicable for 4 poles</p>	 <p>(Top View)</p>	 <p>(Top View)</p>		<p>*plastic retainer 18FF-H4</p> <p>*metallic retainer 18FF-H5</p> <p>*plug-in module HFAA to HFHU</p> <p>marker 18FF-M1</p>
<p>18FF-4Z-C5</p>  <p>Screw Terminal, DIN rail or Screw mounting, With finger protection device Applicable for 4 poles</p>	 <p>(Top View)</p>	 <p>(Top View)</p>		<p>*plastic retainer 18FF-H4</p> <p>*metallic retainer 18FF-H5</p> <p>*plug-in module HFAA to HFHU</p> <p>marker 18FF-M1</p>
<p>18FF-4Z-C8</p>  <p>Screw Terminal, DIN rail or Screw mounting, With finger protection device Applicable for 4 poles</p>	 <p>(Top View)</p>	 <p>(Top View)</p>		<p>*plastic retainer 18FF-H4</p> <p>*metallic retainer 18FF-H5</p> <p>marker 18FF-M3</p> <p>*plug-in module HFAA to HFHU</p>
<p>18FF-4Z-C9</p>  <p>Spring-loaded terminal, DIN rail mounting, With finger protection device Applicable for 4 poles</p>	 <p>(Top View)</p>	 <p>(Top View)</p>		<p>*plastic retainer 18FF-H4</p> <p>*metallic retainer 18FF-H5</p> <p>*plug-in module HFAA to HFHU</p> <p>marker 18FF-M3</p>

Notes: * If need accessory, please order with type.

OUTLINE DIMENSIONS, WIRING DIAGRAM AND PC BOARD LAYOUT

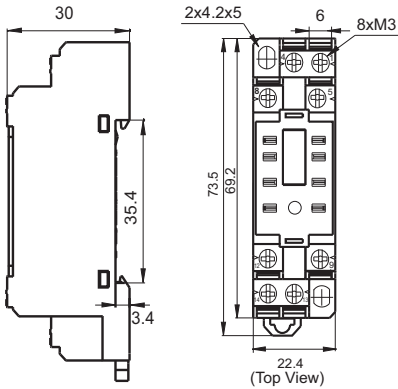
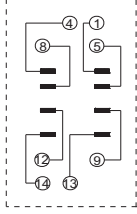
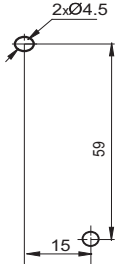
Unit: mm

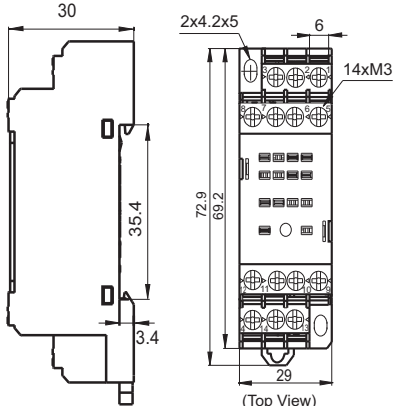
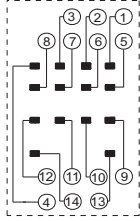
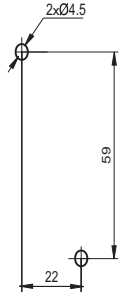
Socket	Outline Dimensions	Wiring Diagram	PCB Layout	Accessory Available
<p>18FZ-2Z-C2</p>  <p>Screw Terminal, DIN rail or Screw mounting, With finger protection device</p>	 <p>30, 35.4, 3.4, 2x4.2x5, 6, 8xM3, 73.5, 69.2, 22.4 (Top View)</p>	 <p>(Top View)</p>	 <p>2xØ4.5, 59, 15</p>	<p>*metallic retainer 18FF-H2 (be used in sets) 18FF-H3</p>
<p>18FZ-4Z-C2</p>  <p>Screw Terminal, DIN rail or Screw mounting, With finger protection device</p>	 <p>30, 35.4, 3.4, 2x4.2x5, 6, 14xM3, 72.9, 69.2, 29 (Top View)</p>	 <p>(Top View)</p>	 <p>2xØ4.5, 59, 22</p>	<p>*metallic retainer 18FF-H2 (be used in sets)</p>

Notes: * If need accessory, please order with type.

DIMENSION OF RELATED ACCESSORY (AVAILABLE)

Unit: mm

Retainer

18FF-H1 (metallic retainer)

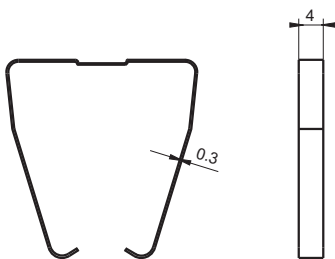

18FF-H2 (metallic retainer)

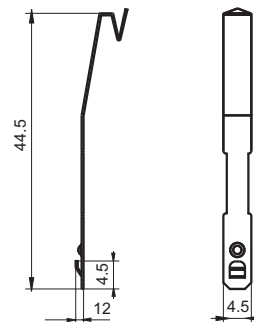

Remark: 18FF-H2 retainer has to be used in sets, please pay special attention while placing the order.

DIMENSION OF RELATED ACCESSORY (AVAILABLE)

Unit: mm

Retainer

18FF-H3 (metallic retainer)

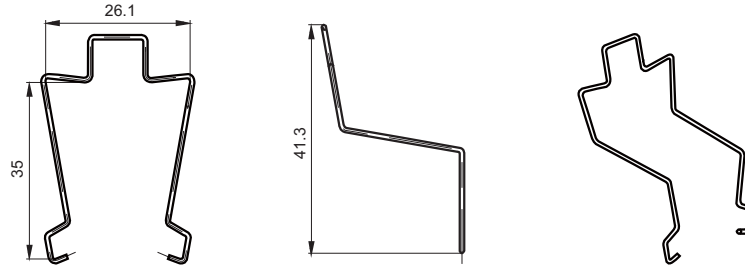

18FF-H4 (plastic retainer)

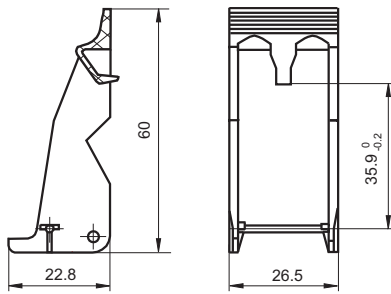

18FF-H5 (metallic retainer)

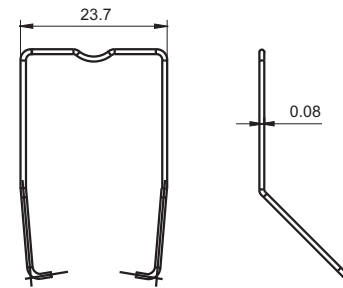

DIMENSION OF RELATED ACCESSORY (AVAILABLE)

Unit: mm

Marker

18FF-M1

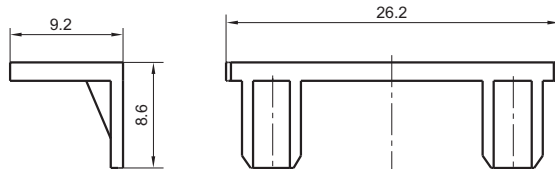

18FF-M3

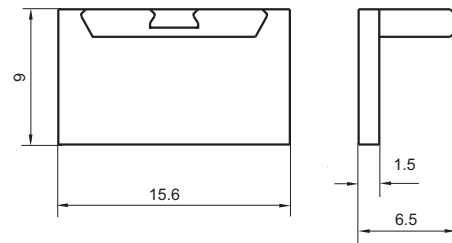

SELECTION OF PARTS

Type of Relay	Mounting termination	Socket	Retainer	Marker	Module	
HF18FF/□ □ -2Z1□ □ □	without button	18FF-2Z-A2	18FF-H1	-	-	
		18FF-2Z-C1	18FF-H2			
		18FF-2Z-C2				
		18FZ-2Z-C2	18FF-H4/H5	18FF-M1	HFAA~HFHU	
		18FF-2Z-C4				
		18FF-2Z-C5				
		18FF-2Z-C8				
		18FF-2Z-C9				
		18FF-3Z-C4				18FF-M3
18FF-3Z-C5						
HF18FF/□ □ -3Z1□ □ □			18FF-M1			
HF18FF/□ □ -4Z1□ □ □	without button	18FF-4Z-A2	18FF-H1	-	-	
		18FF-4Z-C1	18FF-H2			
		18FF-4Z-C2				
		18FZ-4Z-C2	18FF-H4/H5	18FF-M1	HFAA~HFHU	
		18FF-4Z-C4				
		18FF-4Z-C5				
		18FF-4Z-C8				
		18FF-4Z-C9				
		18FF-4Z-C9				18FF-M3
HF18FH/□ □ -2Z1□ □ □	with button	18FF-2Z-C4	18FF-H4/H5	18FF-M1	HFAA~HFHU	
18FF-2Z-C5						
18FF-2Z-C8						
18FF-2Z-C9		18FF-M3				
18FF-3Z-C4						
HF18FH/□ □ -3Z1□ □ □				18FF-3Z-C5		18FF-M1
18FF-4Z-C4						
HF18FH/□ □ -4Z1□ □ □				18FF-4Z-C5		18FF-M1
18FF-4Z-C8						
18FF-4Z-C9	18FF-M3					
HF18FF-G/□ □ -2Z1□ □ □	without button	18FF-2Z-C1(734)	18FF-H2	-	-	
18FF-2Z-C2(734)						
18FF-2Z-C4(734)						
HF18FF-G/□ □ -3Z1□ □ □		18FF-2Z-C5(734)	18FF-H4/H5	18FF-M1	HFAA~HFHU	
18FF-3Z-C5(734)						
HF18FH-G/□ □ -2Z1□ □ □	with button	18FF-2Z-C4(734)				
18FF-2Z-C5(734)						
HF18FH-G/□ □ -3Z1□ □ □		18FF-3Z-C5(734)				

Precautions For Use

For your personal safety and the normal operation of the equipment, as well as to prevent fire, please note the following issues :

- 1.The rated current of the socket should be no less than the rated current of the relay.
- 2.Sockets are required to be firmly fixed to prevent the wiring from loosening and affecting the quality of wiring.
- 3.Be sure to disconnect power to the outlet before installation, disassembly, wiring, maintenance and inspection.
- 4.Prevent foreign objects such as wire shavings from falling inside this product when wiring.
- 5.Be sure to install the relay in place, and use accessories such as retainer if necessary to improve contact reliability. Do not use with incomplete connections.
- 6.Be sure to observe the relay ratings and do not overload the relay.
- 7.Before selecting a relay, make sure that the drive voltage matches the relay excitation voltage.

Precautions for the use of non-threaded terminal type sockets

- 1.Lead end socket description :

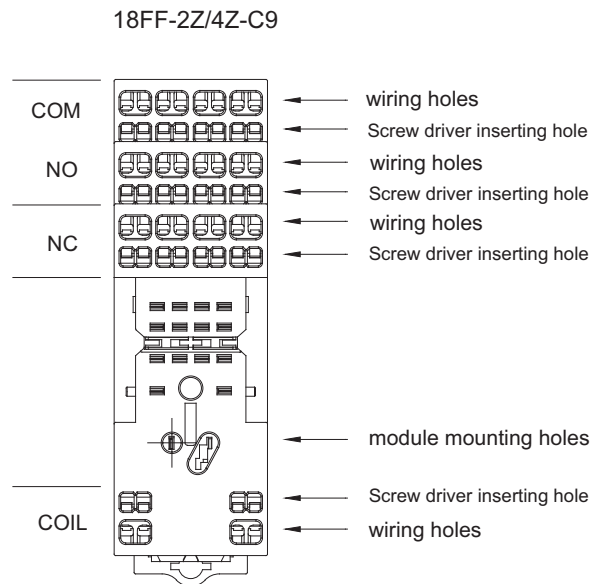

- 2.Things to be noticed when selecting soft wiring.

· The soft wiring can be divided into the following types.

0.5mm² above 1.5mm² below or AWG20 above AWG16 below the stranded wire or a single wire.

The front terminal of the wire needs to be peeled off 8mm to 9mm of insulation protection layer, the wire insulation protection layer diameter *2.8mm or less. Please be sure to use according to this size.

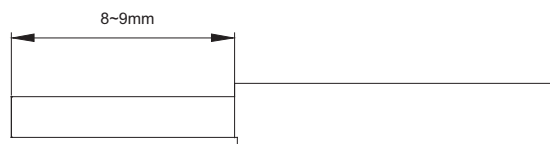

Precautions For Use

- If the protective layer is stripped too short, the wire may be pulled out, and if it is too long, it may be short-circuited to the neighboring wires. If using the stranded wire with cold crimped terminals, please twist the stranded wire tightly before use to avoid loosening the wire.

When wiring, use a screwdriver as shown in the figure.

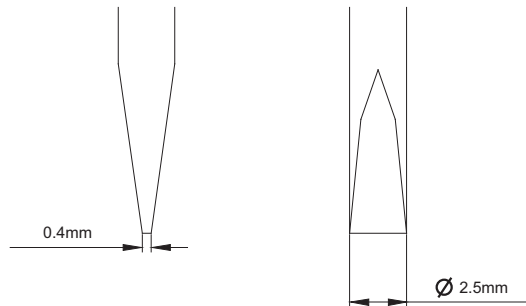

Figure 3

- The insertion position of the wire and the screwdriver and the insertion direction of the screwdriver are as shown in Figure 4.

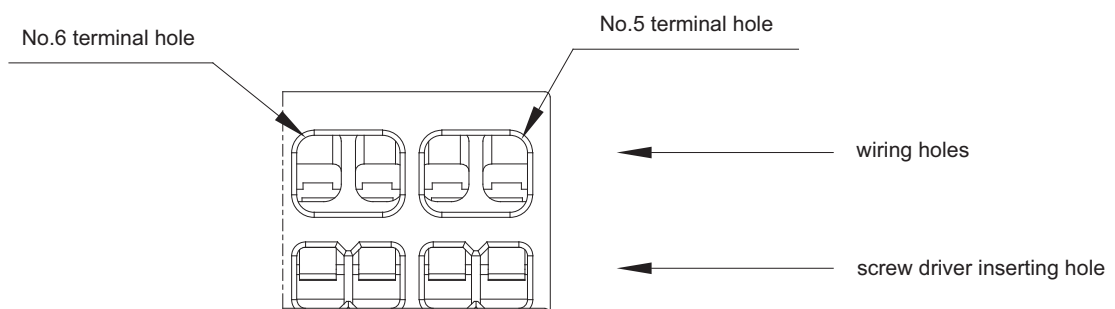

Figure 4

Precautions For Use

- When using stranded wires, use cold crimp terminals with or without plastic sleeves for the stranded wires.
- The method of Wiring as shown in figure 5.

Step 1. Insert the screwdriver into the screwdriver insertion hole (square hole) of the socket so that the screwdriver is inserted in a slightly angled direction until the head of the screwdriver is between the back of the spring terminal and the wall of the cover.

Step 2. Keep pushing the screwdriver in until it contacts the stop position inside the socket and the junction is released, keeping the screwdriver in that position. The screwdriver will not come off even if the hand is released.

Step 3. Keeping the screwdriver in the insertion hole, insert the wire or cold crimp terminal to the bottom of the wire insertion hole.

Step 4. Pull out the screwdriver and the wiring is completed.

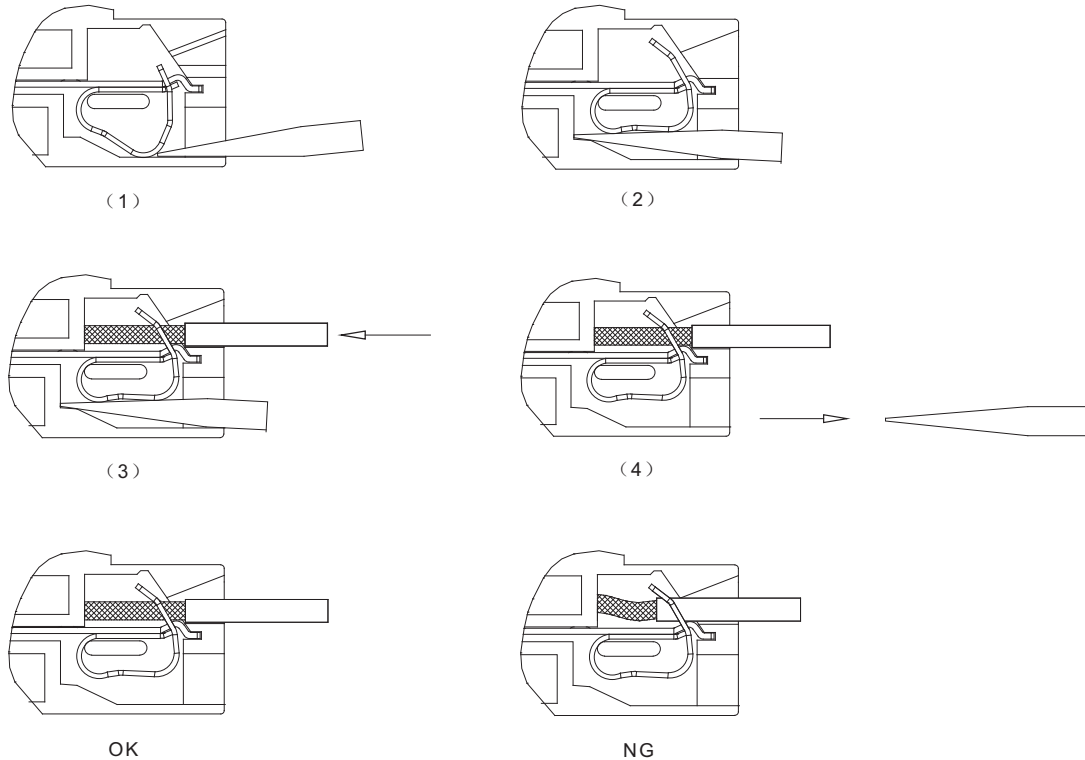

Figure 5

Note : When using wire with insulation protection diameter of 2mm or less, do not insert the insulated part of the wire into the spring clamp opening position .

Things to be noticed when selecting sockets:

1. Please choose suitable relay socket according to the actual mounting environment, relay contact poles and terminal layout. If there is any query on selection, please contact Hongfa for the technical service.
2. Socket which can be mounted with markers is furnished with a marker; as for other related components, they should be selected separately. Please do give clear indication of the types of relay sockets and related components you choose while placing order.
3. The above is only an example of typical socket and related component type which is suitable to HF18FF relay. If you have any special requirements, please contact us.
4. Main outline dimension, outline dimension $>50\text{mm}$,tolerance should be $\pm 1\text{mm}$; $20\text{mm}<\text{outline dimension} \leq 50\text{mm}$, tolerance should be $\pm 0.5\text{mm}$; $5\text{mm}<\text{outline dimension} \leq 20\text{mm}$, tolerance should be $\pm 0.4\text{mm}$; outline dimension $\leq 5\text{mm}$, tolerance should be $\pm 0.3\text{mm}$.
5. DIN rail mounting: recommend to use standard rail $35 \times 7.5 \times 1\text{mm}$, $35 \times 15 \times 1\text{mm}$.

Disclaimer

The specification is for reference only. See to "Terminology and Guidelines" for more information. Specifications subject to change without notice. We could not evaluate all the performance and all the parameters for every possible application. Thus the user should be in a right position to choose the suitable product for their own application. If there is any query, please contact Hongfa for the technical service. However, it is the user's responsibility to determine which product should be used only.

© Xiamen Hongfa Electroacoustic Co., Ltd. All rights of Hongfa are reserved.