

HFV6-G

AUTOMOTIVE RELAY



Typical Applications

Heaters (seat, front/rear windows), Fan motors control, Fuel pump control, Wiper motors control, Headlight control, Air-conditioning, Lighting control, Electromagnet control, Start / Stop control

Features

- 35A switching capability
- Ambient temp.: range up to 125°C
- 1 Form A & 1 Form C contact arrangement
- Plastic sealed and dust protected types available
- RoHS & ELV compliant

CHARACTERISTICS

Contact arrangement	1A, 1C	Vibration resistance ⁴⁾	5Hz to 17.3Hz 10mm DA 17.3Hz to 50Hz 58.9m/s ² 50Hz to 100Hz 29.4m/s ² 100Hz to 200Hz 19.4m/s ²
Voltage drop (initial)	NO:Typ.15mV,250mV max.(at 10A) NC:Typ.25mV,250mV max.(at 10A)	Shock resistance ⁴⁾	196m/s ² (20g)
Max. continuous current ¹⁾	NO: 35A(23°C)、30A(85°C)、18A(125°C) NC: 25A(23°C)、20A(85°C)、10A(125°C)	Flammability ⁵⁾	UL94-HB or better (meets FMVSS 302)
Typ. switching current	Lamp:Make inrush peak current 150A Resistive:Breake 35A	Termination	QC ⁷⁾
Max. switching voltage	16VDC	Construction	Plastic sealed, Dust protected
Min. contact load	1A 6VDC	Unit weight	Approx. 22g
Electrical endurance	1×10 ⁵ OPS	Mechanical data	cover retention (pull & push): 200N min. terminal retention (pull & push): 100N min. terminal resistance to bending (front & side): 10N min. ⁶⁾
Mechanical endurance	1 x 10 ⁷ OPS (300OPS/min)		
Initial insulation resistance	100MΩ (at 500VDC)	1) For NO contacts, measured when applying 100% rated vorage on coil.	
Dielectric strength ²⁾	500VAC	2) 1min, leakage current less than 1mA.	
Operate time	Typ.: 5ms (at nomi. vol.)	3) The value is measured when voltage drops suddenly from nominal voltage to 0 VDC and coil is not paralleled with suppression circuit.	
	Max.: 10ms (at nomi. vol.)	4) When energized, opening time of NO contacts shall not exceed 100μs, when non-energized, opening time of NC contacts shall not exceed 100μs, meantime, NO contacts shall not be closed.	
Release time ³⁾	Typ.: 2ms Max.: 10ms	5) FMVSS: Federal Motor Vehicle Safety Standard.	
Ambient temperature	-40°C to 125°C	6) Test point is at 2mm away from teminal end, and after removing testing force, the terminal transfiguration shall not exceed 0.5mm.	
Storage temperature	-40°C to 155°C	7) Do NOT knock on relays with hard objects such as rubber rod and rubber hammer during mounting, which might lead to relay damage.	

CONTACT DATA ⁴⁾

Load voltage	Load type		Load current A			On/Off ratio		Electrical endurance OPS	Contact material	Load wiring diagram ³⁾	Ambient temp.
			1C		1A	On s	Off s				
			NO	NC							
Standard 13.5VDC	Resistive	Make	35	20	35	2	2	1×10 ⁵	AgSnO ₂	See diagram 1	See Ambient Temp. Curve
		Break	35	20	35						
	Inductive	Make ¹⁾	80	---	80	2	2	1×10 ⁵	AgSnO ₂	See diagram 2	
		Break	30	---	30						
	Lamp	Make	150 ²⁾	---	150 ²⁾	2	2	1×10 ⁵	AgSnO ₂	See diagram 3	
		Break	30	---	30						



HONGFA RELAY

ISO9001, IATF16949, ISO14001, OHSAS18001, IECQ QC 080000 CERTIFIED

- 1) Corresponds to the peak inrush current on initial actuation.
- 2) Corresponds to the peak inrush current on initial actuation (cold filament).
- 3) The load wiring diagrams are listed below:

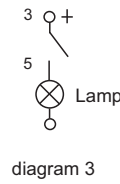
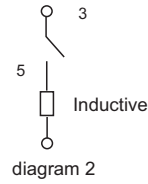
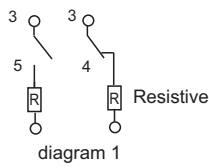

- 4) Loads mentioned in this chart is for relays with no parallel diode or Zener Diode. For those with parallel diode, Zener Diode or other components, please contact Hongfa for more technical supports.
Please also contact Hongfa if the actual application load is different from what mentioned above.

COIL DATA

at 23°C

	Nominal voltage VDC	Pick-up voltage VDC max.	Drop-out voltage VDC min.	Coil resistance $\times(1\pm 10\%)\Omega$	Parallel resistance ¹⁾ $\times(1\pm 5\%)\Omega$	Equivalent resistance $\times(1\pm 10\%)\Omega$	Power consumption W	Max. allowable overdrive voltage ²⁾ VDC	
								at 23°C	at 85°C
Standard	12	8	1.0	124	---	---	1.16	20	15
	12	8	1.0	124	680	104.9	1.37	20	15

1) The power consumption of parallel resistance is 0.5W.

2) Max. allowable overdrive voltage is stated with no load applied and minimum coil resistance.

ORDERING INFORMATION

	HFV6-G /	12	-Z	S	T	N	-R	(XXX)
Type								
Coil voltage	12: 12VDC							
Contact arrangement	H: 1 Form A Z: 1 Form C							
Construction ¹⁾	S: Plastic sealed ²⁾ Nil: Dust protected							
Contact material	T: AgSnO₂							
QC Coil Terminal width	N: 2.8 mm Nil: 4.8 mm							
Parallel coil components ²⁾	R: Parallel transient suppression resistors D: Parallel transient suppression diode, with anode connected to terminal#2 D1: Parallel transient suppression diode, with anode connected to terminal#1 Nil: Without parallel components							
Special code ³⁾	XXX: Customer special requirement				Nil: Standard			

Notes: 1) In environments with high humidity, moisture, or even condensation, and dust, such as relays used in engineering, mining, agriculture and other fields, or relays with mounting brackets installed outside of electrical boxes, It is recommended to use plastic-encapsulated products; in environments containing phosphorus, H₂S, SO₂, NO₂ and other harmful gases, plastic-encapsulated types must be used and tested and confirmed in actual use; in environments containing organic silicon, please avoid using dust-proof covers ;

2) If parallel diode, Zener Diode or other components are required, please contact Hongfa for more technical supports.

3) The performance parameters of products with characteristic numbers shall be subject to the specific specifications provided by Hongfa.

OUTLINE DIMENSIONS AND WIRING DIAGRAM

Unit: mm

Outline Dimensions

HFV6-G/12-Z□□□(XXX)

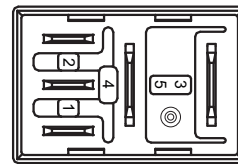
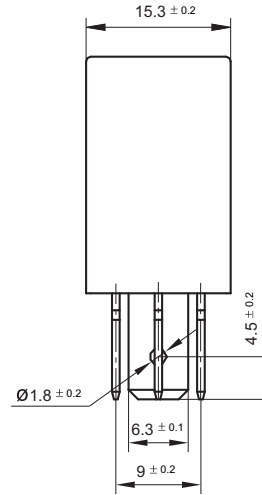
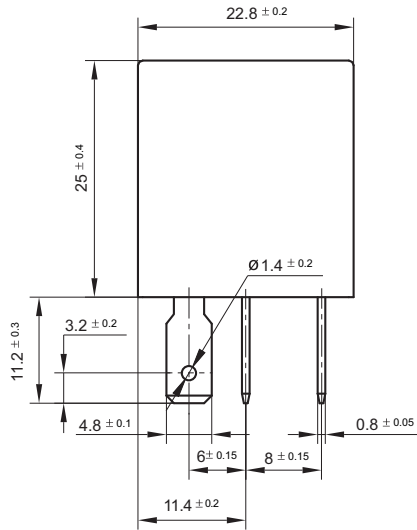

(Bottom view)

HFV6-G/12-Z□□□N□(XXX)

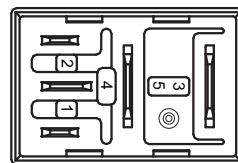
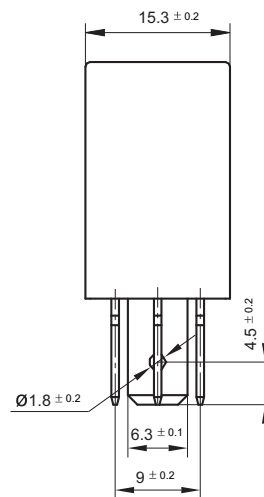
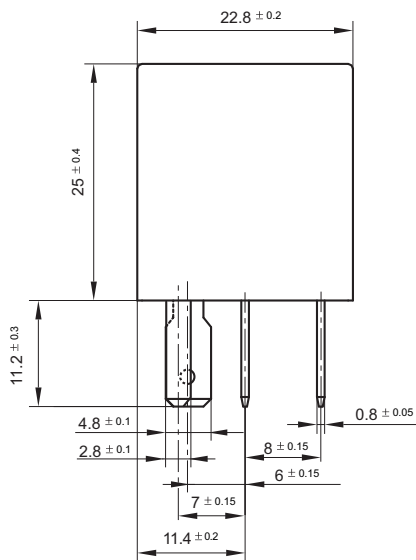

(Bottom view)

Remark: Terminal vertical deviation tolerance is 0.3mm.

Wiring Diagram

HFV6-G/12-H□□□(XXX)

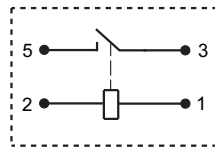

HFV6-G/12-Z□□□(XXX)

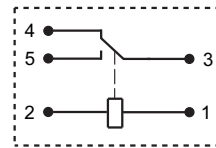

HFV6-G/12-H□□□-R(XXX)

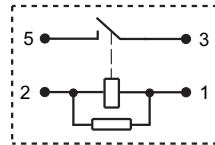

HFV6-G/12-Z□□□-R(XXX)

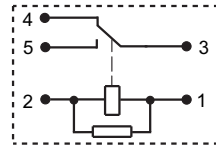

HFV6-G/12-H□□□-D(XXX)

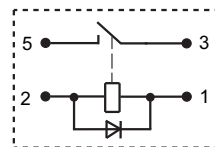

HFV6-G/12-Z□□□-D(XXX)

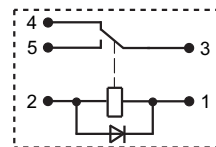

HFV6-G/12-H□□□-D1(XXX)

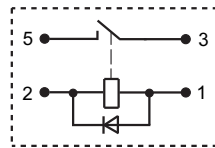

HFV6-G/12-Z□□□-D1(XXX)

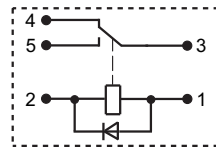

CHARACTERISTIC CURVES

Ambient temperature curve of the electrical endurance test

Ambient temp. curve (one cycle)

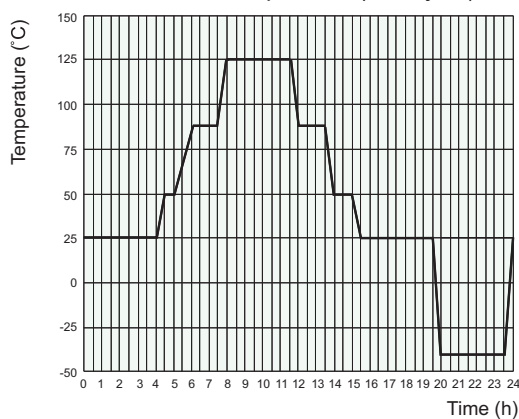

- 1) The minimum temperature is -40°C.
- 2) The maximum temperature is 125°C.

Disclaimer

The specification is for reference only. See to "Terminology and Guidelines" for more information. Specifications subject to change without notice. In case there is specific criterion (such as mission profile, technical specification, PPAP etc.) checked and agreed by and between customer and Hongfa, this specific criterion should be taken as standard regarding any requirement on Hongfa product.

We could not evaluate all the performance and all the parameters for every possible application. Thus the user should be in a right position to choose the suitable product for their own application. If there is any query, please contact Hongfa for the technical service. However, it is the user's responsibility to determine which product should be used only.

© Xiamen Hongfa Electroacoustic Co., Ltd. All rights of Hongfa are reserved.