

# 2.8inch SPI Module MSP2807 User Manual

## Product Description

The LCD module uses a 4-wire SPI communication method with a driver IC of ILI9341 with a resolution of 240x320 and a touch function (optional). The module includes an LCD display, backlight control circuitry, and touch screen control circuitry.

## Product Features

- 2.8-inch color screen, support 16-bit 65K color display, display rich colors
- 240X320 resolution with optional touch function
- Using the SPI serial bus, it only takes a few IOs to illuminate the display
- Easy to expand the experiment with SD card slot
- Provide a rich sample program
- Military-grade process standards, long-term stable work
- Provide underlying driver technical support

## Product Parameters

Name	Description
Display Color	RGB 65K color
SKU	have touch screen: <b>MSP2807</b>
	have no touch screen: <b>MSP2806</b>
Screen Size	2.8(inch)
Type	TFT
Driver IC	ILI9341
Resolution	320*240 (Pixel)
Module Interface	4-wire SPI interface
Active Area	43.2x57.6 (mm)
Module PCB Size	50.0x86.0 (mm)
Angle of view	>60°

Operating Temperature	-20°C~70°C
Storage Temperature	-30°C~80°C
Operating Voltage	3.3V / 5V
Power Consumption	About 90mA
Product Weight	About 25(g)

## Interface Description

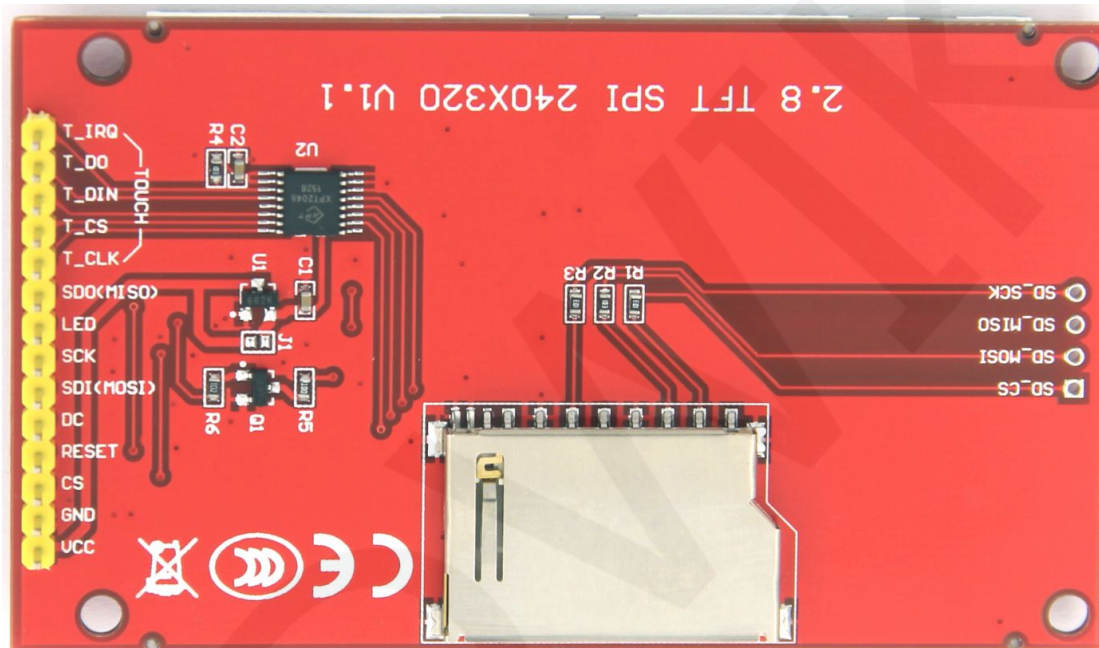

Pin silkscreen picture

Number	Module Pin	Pin Description
1	VCC	LCD power supply is positive (3.3V~5V)
2	GND	LCD Power ground
3	CS	LCD selection control signal
4	RESET	LCD reset control signal
5	DC/RS	LCD register / data selection control signal
6	SDI(MOSI)	LCD SPI bus write data signal
7	SCK	LCD SPI bus clock signal
8	LED	LCD backlight control signal (high level lighting, if you do not need control, please connect 3.3V)
9	SDO(MISO)	LCD SPI bus read data signal (can not be connected)

		if not needed)
The following is the touch screen signal line wiring, if you do not need to touch function or the module itself does not have touch function, you can not connect them		
10	T_CLK	Touch screen SPI bus clock pin
11	T_CS	Touch screen chip select control pin
12	T_DIN	Touch screen SPI bus write data pin
13	T_DO	Touch screen SPI bus read data pin
14	T_IRQ	Touch screen interrupt detection pin

## Hardware Configuration

The LCD module hardware circuit includes three parts: an LCD display control circuit, a touch screen control circuit, and a backlight control circuit.

The LCD display control circuit is used to control the pins of the LCD, including control pins and data transfer pins.

The touch screen control circuit can control touch screen touch corresponding and touch coordinate reading (touch screen optional).

The backlight control circuit is used to control the backlight to be on and off. Of course, if the backlight is not required to be controlled, the backlight control pin can be directly connected to the 3.3V power supply without using the circuit.

## working principle

### 1. Introduction to ILI9341 Controller

The ILI9341 controller supports a maximum resolution of 240\*320 and a 172800-byte GRAM. It also supports 8-bit, 9-bit, 16-bit, and 18-bit parallel port data buses. It also supports 3-wire and 4-wire SPI serial ports. Since parallel control requires a large number of IO ports, the most common one is SPI serial port control. The ILI9341 also supports 65K, 262K RGB color display, display color is very rich, while supporting rotating display and scroll display and video playback, display in a variety of ways.

The ILI9341 controller uses 16bit (RGB565) to control a pixel display, so it can display up to 65K colors per pixel. The pixel address setting is performed in the order of

rows and columns, and the incrementing and decreasing direction is determined by the scanning mode. The ILI9341 display method is performed by setting the address and then setting the color value.

## 2. Introduction to SPI communication protocol

The 4-wire SPI bus write mode timing is shown in the following figure:

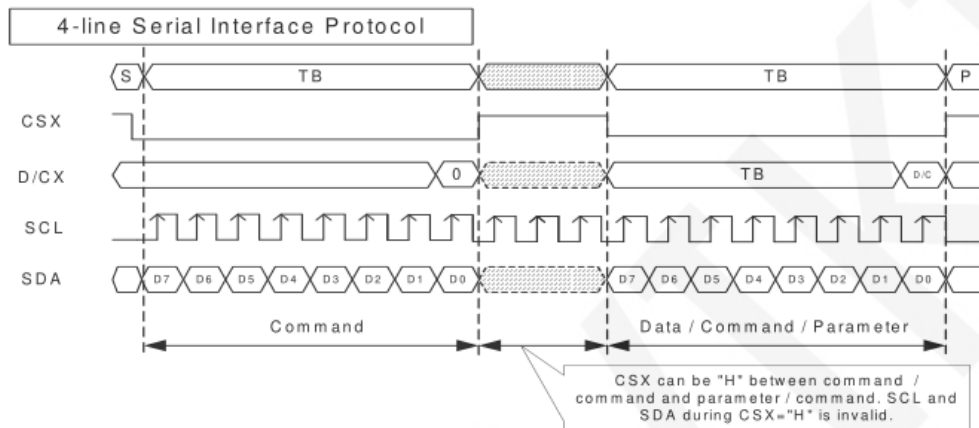

CSX is a slave chip select, and the chip is enabled only when CSX is low.

D/CX is the data/command control pin of the chip. When DCX is low, the command is written. When it is high, the data is written.

SCL is the SPI bus clock, and each rising edge transmits 1 bit of data;

SDA is the data transmitted by SPI, and it transmits 8-bit data at a time. The data format is as shown below:

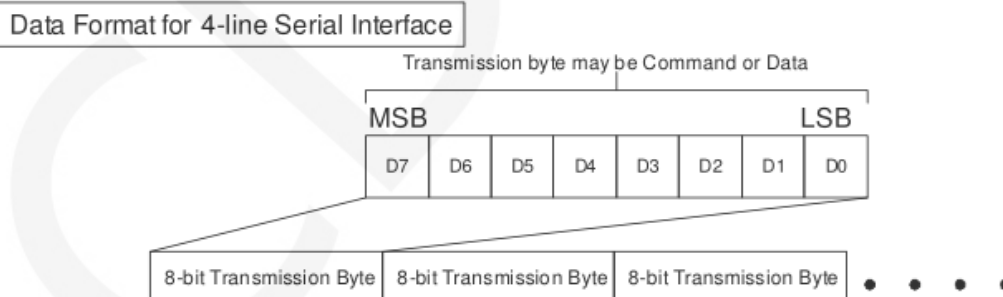

The high position is in front and transmitted first.

For SPI communication, the data has a transmission timing, that is, a combination of clock phase (CPHA) and clock polarity (CPOL):

The CPOL level determines the idle state level of the serial synchronous clock, CPOL = 0, which is low. CPOL does not have a lot of impact on the transport protocol;

The level of CPHA determines whether the serial synchronous clock is acquired on the first clock transition edge or the second clock transition edge.

When CPHL = 0, data acquisition is performed on the first edge of the transition;

The combination of the two becomes the four SPI communication methods. SPI0 is usually used in China, that is, CPHL = 0, CPOL = 0.

## Instructions for use

### 1. Arduino instructions

Wiring instructions:

Arduino UNO microcontroller test program wiring		
Number	Module Pin	Corresponding to UNO development board wiring pins
1	SDO(MISO)	12
2	LED	A0
3	SCK	13
4	SDI(MOSI)	11
5	DC/RS	A3
6	RESET	A4
7	CS	A5
8	GND	GND
9	VCC	5V/3.3V
10	T_IRQ	6
11	T_DO	4
12	T_DIN	5
13	T_CS	2
14	T_CLK	3

Arduino MEGA2560 microcontroller test program wiring		
Number	Module Pin	Corresponding to MEGA2560 development board wiring pins
1	SDO(MISO)	50

2	LED	A0
3	SCK	52
4	SDI(MOSI)	51
5	DC/RS	A3
6	RESET	A4
7	CS	A5
8	GND	GND
9	VCC	5V/3.3V
10	T_IRQ	49
11	T_DO	47
12	T_DIN	48
13	T_CS	45
14	T_CLK	46

#### Operating Steps:

- A. First refer to the method of running the SPI module on the Arduino. The specific method is as follows:  
[http://www.lcdwiki.com/Run\\_Arduino\\_Demo\\_in\\_spi\\_model](http://www.lcdwiki.com/Run_Arduino_Demo_in_spi_model)
- B. Connect the LCD module and the Arduino MCU according to the above wiring instructions, and power on;
- C. Copy the dependent libraries in the Install libraries directory of the test package to the libraries folder of the Arduino project directory (if you do not need to depend on the libraries, you do not need to copy them);
- D. Open the directory where the Arduino test program is located and select the example you want to test, as shown below:  
(Please refer to the test program description document in the test package for the test program description)

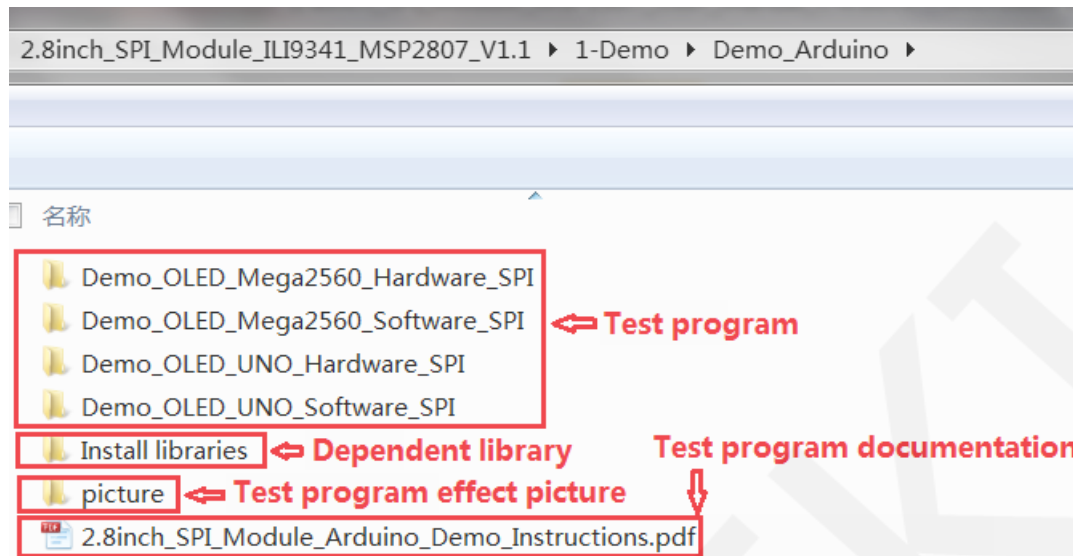

E. Open the selected sample project, compile and download.

The specific operation methods for the Arduino test program relying on library copy, compile and download are as follows:

[http://www.lcdwiki.com/res/PublicFile/Arduino\\_IDE\\_Use\\_Illustration\\_EN.pdf](http://www.lcdwiki.com/res/PublicFile/Arduino_IDE_Use_Illustration_EN.pdf)

F. If the LCD module displays characters and graphics normally, the program runs successfully;

## 2. C51 instructions

Wiring instructions:

STC89C52RC and STC12C5A60S2 microcontroller test program wiring instructions		
Number	Module Pin	Corresponding to STC89/STC12 development board wiring pin
1	VCC	5V/3.3V
2	GND	GND
3	CS	P13
4	RESET	P33
5	DC/RS	P12
6	SDI(MOSI)	P15
7	SCK	P17
8	LED	P32



9	SDO(MISO)	P16
10	T_CLK	P36
11	T_CS	P37
12	T_DIN	P34
13	T_DO	P35
14	T_IRQ	P40

### Operating Steps:

- A. Connect the LCD module and the C51 MCU according to the above wiring instructions, and power on;
- B. Select the C51 test program to be tested, as shown below:  
(Please refer to the test program description document in the test package for the test program description)

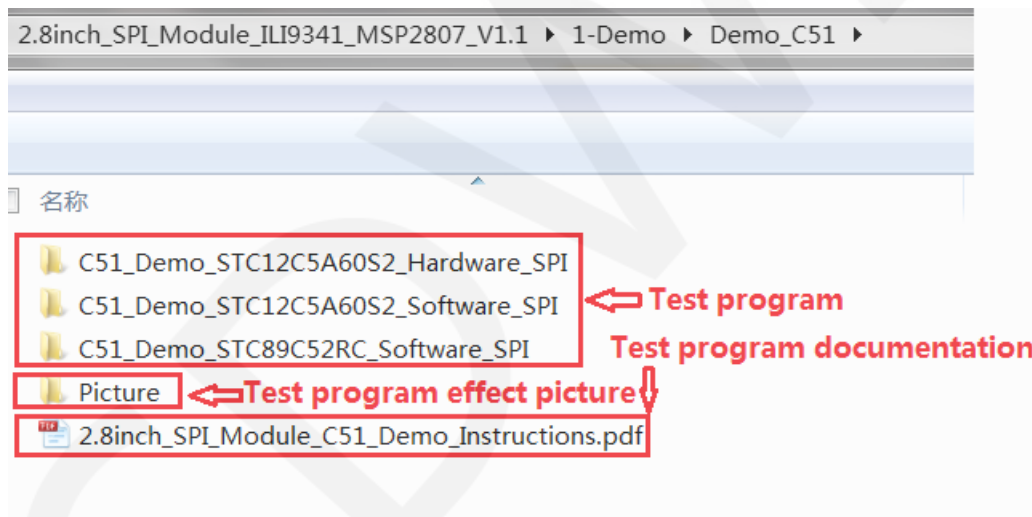

- C. Open the selected test program project, compile and download;  
detailed description of the C51 test program compilation and download can be found in the following document:  
[http://www.lcdwiki.com/res/PublicFile/C51\\_Keil%26stc-isp\\_Use\\_Illustration\\_EN.pdf](http://www.lcdwiki.com/res/PublicFile/C51_Keil%26stc-isp_Use_Illustration_EN.pdf)
- D. If the LCD module displays characters and graphics normally, the program runs successfully;

## 3. STM32 instructions

### Wiring instructions:

Because the pin positions of different development boards are different, and the external pins are reserved differently (some development boards do not have externally required pins). In order to facilitate wiring, the wiring pins of each development board are inconsistent.

<b>STM32F103RCT6 microcontroller test program wiring instructions</b>		
<b>Number</b>	<b>Module Pin</b>	<b>Corresponding to MiniSTM32 development board wiring pin</b>
1	VCC	5V/3.3V
2	GND	GND
3	CS	PB11
4	RESET	PB12
5	DC/RS	PB10
6	SDI(MOSI)	PB15
7	SCK	PB13
8	LED	PB9
9	SDO(MISO)	PB14
10	T_CLK	PC0
11	T_CS	PC13
12	T_DIN	PC3
13	T_DO	PC2
14	T_IRQ	PC10

<b>STM32F103ZET6 microcontroller test program wiring instructions</b>		
<b>Number</b>	<b>Module Pin</b>	<b>Corresponding to Elite STM32 development board wiring pin</b>
1	VCC	5V/3.3V
2	GND	GND

3	CS	PB11
4	RESET	PB12
5	DC/RS	PB10
6	SDI(MOSI)	PB15
7	SCK	PB13
8	LED	PB9
9	SDO(MISO)	PB14
10	T_CLK	PC0
11	T_CS	PC13
12	T_DIN	PC3
13	T_DO	PC2
14	T_IRQ	PC10

### STM32F407ZGT6 microcontroller test program wiring instructions

Number	Module Pin	Corresponding to Explorer STM32F4 development board wiring pin
1	VCC	5V/3.3V
2	GND	GND
3	CS	PB15
4	RESET	PB12
5	DC/RS	PB14
6	SDI(MOSI)	PB5
7	SCK	PB3
8	LED	PB13
9	SDO(MISO)	PB4
10	T_CLK	PB0
11	T_CS	PC5
12	T_DIN	PF11

13	T_DO	PB2
14	T_IRQ	PB1

STM32F429IGT6 microcontroller test program wiring instructions		
Number	Module Pin	Corresponding to Apollo STM32F4/F7 development board wiring pin
1	VCC	5V/3.3V
2	GND	GND
3	CS	PD11
4	RESET	PD12
5	DC/RS	PD5
6	SDI(MOSI)	PF9
7	SCK	PF7
8	LED	PD6
9	SDO(MISO)	PF8
10	T_CLK	PH6
11	T_CS	PI8
12	T_DIN	PI3
13	T_DO	PG3
14	T_IRQ	PH11

### Operating Steps:

- A. Connect the LCD module and the STM32 MCU according to the above wiring instructions, and power on;
- B. Select the test example according to the model of the microcontroller, as shown in the following figure:  
(Please refer to the test program description document in the test package for the test program description)

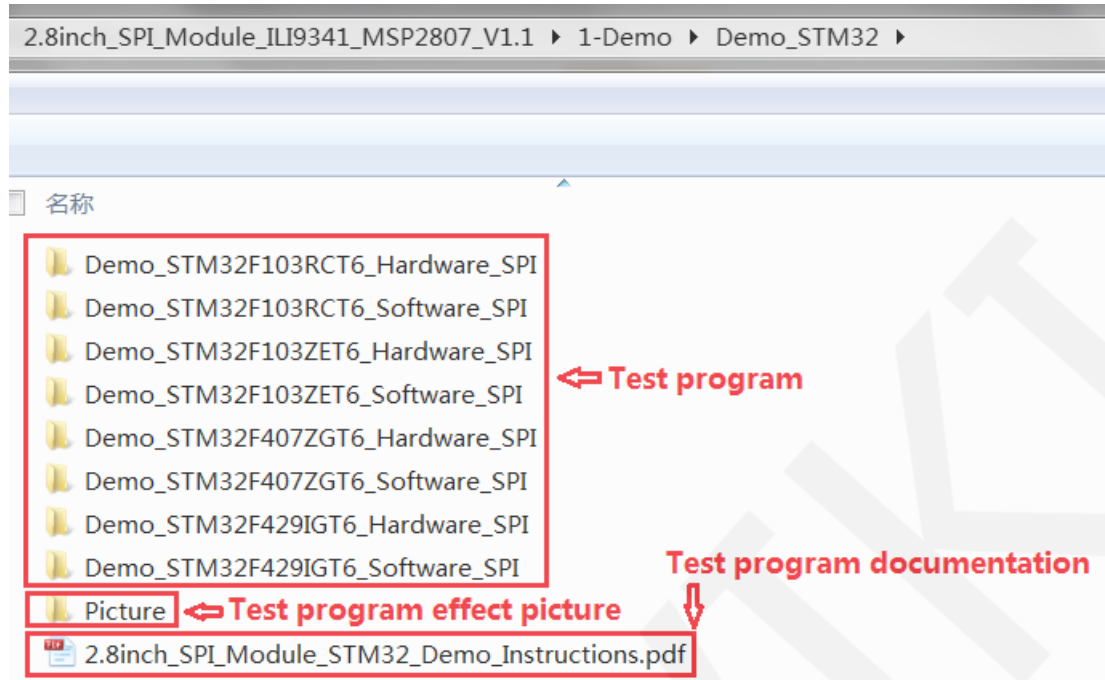

- C. Open the selected test program project, compile and download; detailed description of the STM32 test program compilation and download can be found in the following document:

[http://www.lcdwiki.com/res/PublicFile/STM32\\_Keil\\_Use\\_Illustration\\_EN.pdf](http://www.lcdwiki.com/res/PublicFile/STM32_Keil_Use_Illustration_EN.pdf)

- D. If the LCD module displays characters and graphics normally, the program runs successfully;

## Software Description

### 1. Code Architecture

#### A. Arduino code architecture description

The code architecture is shown below:

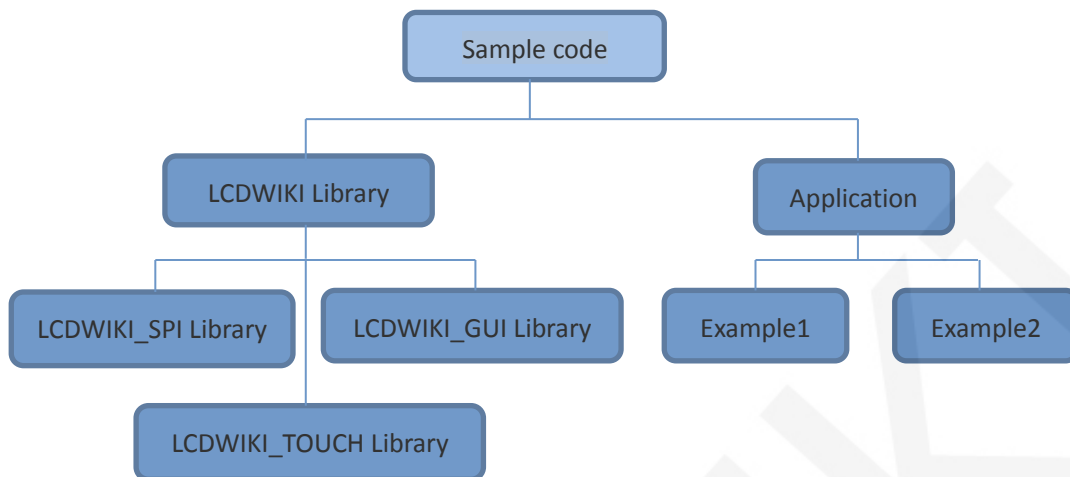

Arduino's test program code consists of two parts: the LCDWIKI library and application code.

The LCDWIKI library consists of three parts: the LCDWIKI\_SPI library, the LCDWIKI\_GUI library, and the LCDWIKI\_TOUCH library.

The application contains several test examples, each of which contains different test content.

LCDWIKI\_SPI is the underlying library, which is associated with hardware. It is mainly responsible for operating registers, including hardware module initialization, data and command transmission, pixel coordinates and color settings, and display mode configuration.

LCDWIKI\_GUI is a middle-tier library, which is responsible for drawing graphics and displaying characters using the API provided by the underlying library.

LCDWIKI\_TOUCH is the underlying library of touch screens, mainly responsible for touch interrupt detection, touch data sampling and AD conversion, and touch data transmission.

The application uses the API provided by the LCDWIKI library to write some test examples to implement some aspects of the test function.

## B. C51 and STM32 code architecture description

The code architecture is shown below:

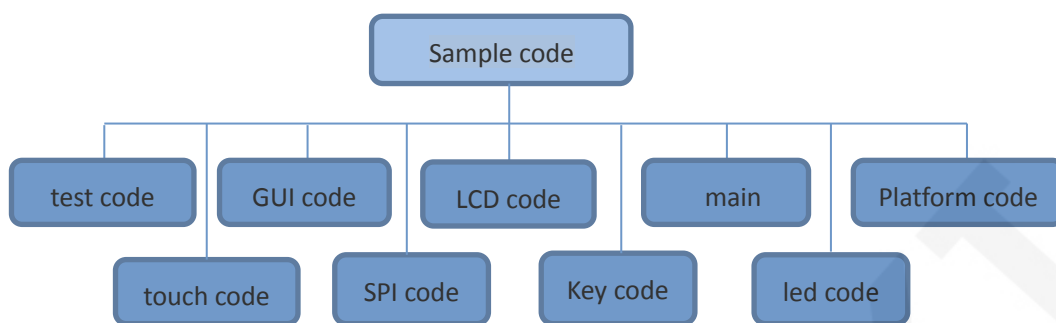

The Demo API code of the main program runtime is included in the test code;

LCD initialization and related operations are included in the LCD code;

Drawing points, lines, graphics, and Chinese and English character display related operations are included in the GUI code;

The main function implements the application to run;

Platform code varies by platform;

Touch screen related operations are included in the touch code;

SPI initialization and configuration related operations are included in the SPI code;

The key processing related code is included in the key code (the C51 platform does not have a button processing code);

The code related to the led configuration operation is included in the led code;

## 2. software SPI and hardware SPI description

The LCD module provides software SPI and hardware SPI sample code (except STC89C52RC, because it does not have hardware SPI function), the two sample code does not make any difference in the display content, but the following aspects are different:

### A. display speed

The hardware SPI is significantly faster than the software SPI, which is determined by the hardware.

### B. GPIO definition

The software SPI all control pins must be defined, any idle pin can be used, the hardware SPI data and clock signal pins are fixed (depending on the platform),

other control pins should be defined by themselves, or any idle reference can be used. foot.

### C. initialization

When the software SPI is initialized, only the GPIO for pin definition needs to be initialized (not required by the C51 platform). When the hardware SPI is initialized, the relevant control registers and data registers need to be initialized.

## 3. GPIO definition description

### A. Arduino test program GPIO definition description

The LCD screen and touch screen GPIO definitions of the Arduino test program are placed separately in each application, which means that each application can flexibly define GPIO according to requirements. As shown below (take UNO software SPI test program as an example):

```
//paramters define
#define MODEL ILI9341
#define CS A5
#define CD A3
#define RST A4
#define MOSI 11
#define MISO 12
#define SCK 13
#define LED A0 //if you don't need to control the I

//touch screen paramters define
#define TCS 2
#define TCLK 3
#define TDOUT 4
#define TDIN 5
#define TIRQ 6
```

 LCD GPIO definition

 Touch screen GPIO definition

**Note:** The touch screen GPIO is defined using the touch test program.

### B. C51 test program GPIO definition description

The GPIO definition related to the LCD of the C51 is placed in the lcd.h file as shown below:



```
//IO连接
sbit LCD_RS = P1^2;      //数据/命令切换
sbit LCD_SDI = P1^5;    //SPI写
sbit LCD_SDO = P1^6;    //SPI读
sbit LCD_CS = P1^3;     //片选
sbit LCD_CLK = P1^7;    //SPI时钟
sbit LCD_RESET = P3^3;  //复位
sbit LCD_BL=P3^2;      //背光控制，如果不需要控制，接3.3V
```

If the software SPI is used, all pin definitions can be modified and can be defined as any other free GPIO.

If hardware SPI is used, the LCD\_BL, LCD\_RS, LCD\_CS, and LCD\_RST pin definitions can be modified and can be defined as any other free GPIO. LCD\_CLK and LCD\_SDI do not need to be defined.

The touch screen related GPIO definition is placed in the touch.h file, as shown below (take the STC12C5A60S2 microcontroller test program as an example):

```
sfr P4 = 0xC0;
sbit DCLK = P3^6;
sbit TCS = P3^7;
sbit DIN = P3^4;
sbit DOUT = P3^5;
sbit Penirq = P4^0; //检测触摸屏响应信号
```

The GPIO definition of the touch screen can be modified and can be defined as any other free GPIO.

If the microcontroller does not have a P4 GPIO group, penirq can be defined as other GPIOs.

### C. STM32 test program GPIO definition description

The STM32 LCD screen non-SPI GPIO definition is placed in lcd.h, as shown below (take STM32F103RCT6 microcontroller test program as an example):

```
#define LED 13 //背光控制引脚
#define CS 15 //片选引脚
#define RS 14 //寄存器/数据选择引脚
#define RST 12 //复位引脚
```

All pin definitions can be modified and can be defined as any other free GPIO.

The GPIO definition of the STM32 LCD SPI is placed in spi.h as shown below (take the STM32F103RCT6 microcontroller test program as an example):

```
#define SCLK      3 //PB13--->>TFT --SCL/SCK
#define MISO      4
#define MOSI      5 //PB15 MOSI--->>TFT --SDA/DIN
```

If the software SPI is used, all pin definitions can be modified and can be defined as any other free GPIO.

If hardware SPI is used, these pins do not need to be defined. At the same time, the SCLK, MISO and MOSI pins need to be initialized and removed in the LCD\_GPIOInit function in the lcd.c file, as shown in the following figure (take the STM32F103RCT6 microcontroller test program as an example):

```
void LCD_GPIOInit(void)
{
    GPIO_InitTypeDef GPIO_InitStructure;

    RCC_AHB1PeriphClockCmd(RCC_AHB1Periph_GPIOB ,ENABLE);

    GPIO_InitStructure.GPIO_Pin = GPIO_Pin_3|GPIO_Pin_5|GPIO_Pin_12| GPIO_Pin_13|GPIO_Pin_14| GPIO_Pin_15;
    GPIO_InitStructure.GPIO_Mode = GPIO_Mode_OUT; //普通输出模式
    GPIO_InitStructure.GPIO_Speed = GPIO_Speed_100MHz;
    GPIO_InitStructure.GPIO_OType = GPIO_OType_PP; //推挽输出
    GPIO_InitStructure.GPIO_PuPd = GPIO_PuPd_UP; //上拉
    GPIO_Init(GPIOB, &GPIO_InitStructure);

    GPIO_InitStructure.GPIO_Pin = GPIO_Pin_4;
    GPIO_InitStructure.GPIO_Mode = GPIO_Mode_IN;
    GPIO_Init(GPIOB, &GPIO_InitStructure);
}
```

The contents of the red circle must be removed.

The GPIO definition related to the STM32 touch screen is placed in the touch.h file as shown below (take the STM32F103RCT6 microcontroller test program as an example):

```
//与触摸屏芯片连接引脚
//与触摸屏芯片连接引脚
#define PEN PCin(10) //PC10 INT
#define DOUT PCin(2) //PC2 MISO PC2--PB14
#define TDIN PCout(3) //PC3 MOSI PC3--PB15
#define TCLK PCout(0) //PC0 SCLK PC0--PB13
#define TCS PCout(13) //PC13 CS
```

Modify the value in the brackets, all pin definitions can be modified, can be defined as any other free GPIO.

## 4. SPI communication code implementation

### A. Arduino test program SPI communication code implementation

Hardware SPI communication is implemented by the system. We only need to operate the register and call the relevant function. For details, please refer to the MCU related documentation.

The software SPI communication code is implemented in the LCDWIKI\_SPI.cpp file of the LCDWIKI\_SPI library, as shown below:

```
//spi write for hardware and software
void LCDWIKI_SPI::Spi_Write(uint8_t data)
{
    if(hw_spi)
    {
        SPI.transfer(data);
    }
    else
    {
        uint8_t val = 0x80;
        while(val)
        {
            if(data&val)
            {
                MOSI_HIGH;
            }
            else
            {
                MOSI_LOW;
            }
            CLK_LOW;
            CLK_HIGH;
            val >>= 1;
        }
    }
} // end spi_write
```

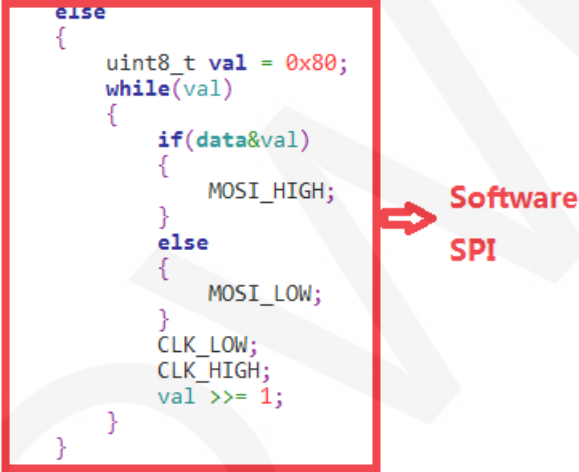

If the transmitted data bit is 1, the SPI data pin is pulled high. When it is 0, the SPI data pin is pulled low, one byte of data is transferred each time, the upper bit is first, and one bit of data is transmitted on each rising edge of the clock.

### B. C51 and STM32 test program SPI communication code implementation

Hardware SPI communication is implemented by the system. We only need to operate the register and call the relevant function. For details, please refer to the MCU related documentation.

The software SPI communication code is implemented in lcd.c and spi.c respectively, and the software SPI implementation method is the same, as shown in the following figure:

```
void SPIv_WriteData(u8 Data)
{
    unsigned char i=0;
    for(i=8;i>0;i--)
    {
        if(Data&0x80)
            LCD_SDA_SET; //输出数据
        else
            LCD_SDA_CLR;
        LCD_SCL_CLR;
        LCD_SCL_SET;
        Data<<=1;
    }
}
```

If the transmitted data bit is 1, the SPI data pin is pulled high. When it is 0, the SPI data pin is pulled low, one byte of data is transferred each time, the upper bit is first, and one bit of data is transmitted on each rising edge of the clock.

## 5. touch screen calibration instructions

### A. Arduino test program touch screen calibration instructions

Arduino touch screen calibration needs to run the touch\_screen\_calibration program first, and then calibrate according to the prompts. After the calibration is passed, the calibration parameters displayed on the screen need to be written into the cali\_para.h file of the LCDWIKI\_TOUCH library, as shown below:

```
//for resolution 240x320,the calibration parameter is 663,-13,894,-30
//for resolution 320x480,the calibration parameter is 852,-14,1284,-30

#define XFAC      852 //663
#define XOFFSET  (-14) //(-13)
#define YFAC      1284 //894
#define YOFFSET  (-30)
```

### B. C51 test program touch screen calibration instructions

The C51 touch screen calibration needs to execute the Touch\_Adjust test item (only available in the STC12C5A60S2 test program), as shown below:

```
//循环进行各项测试
while(1)
{
    main_test(); //测试主界面
    Test_Color(); //简单刷屏填充测试
    Test_FillRec(); //GUI矩形绘图测试
    Test_Circle(); //GUI画圆测试
    Test_Triangle(); //GUI三角形填充测试
    English_Font_test(); //英文字体示例测试
    Chinese_Font_test(); //中文字体示例测试
    Pic_test(); //图片显示示例测试
    Rotate_Test();
    //不使用触摸或者模块本身不带触摸，请屏蔽下面触摸屏测试
    Touch_Test(); //触摸屏手写测试
    //需要触摸校准时，请将触摸手写测试屏蔽，将下面触摸校准测试项打开
    // Touch_Adjust(); //触摸校准
}
```

After the touch calibration is passed, you need to save the calibration parameters displayed on the screen in the touch.c file, as shown below:

```
/**因触摸屏批次不同等原因，默认的校准参数值可能会引起触摸
u16 vx=11738,vy=7736; //比例因子，此值除以1000之后表示多少
u16 chx=3905,chy=246; //默认像素点坐标为0时的AD起始值
/**因触摸屏批次不同等原因，默认的校准参数值可能会引起触摸
```

### C. STM32 test program touch screen calibration instructions

The STM32 touch screen calibration program automatically recognizes whether calibration is required or manually enters calibration by pressing a button.

It is included in the touch screen test item. The calibration mark and calibration parameters are saved in the AT24C02 flash. If necessary, read from the flash. The calibration process is as shown below:

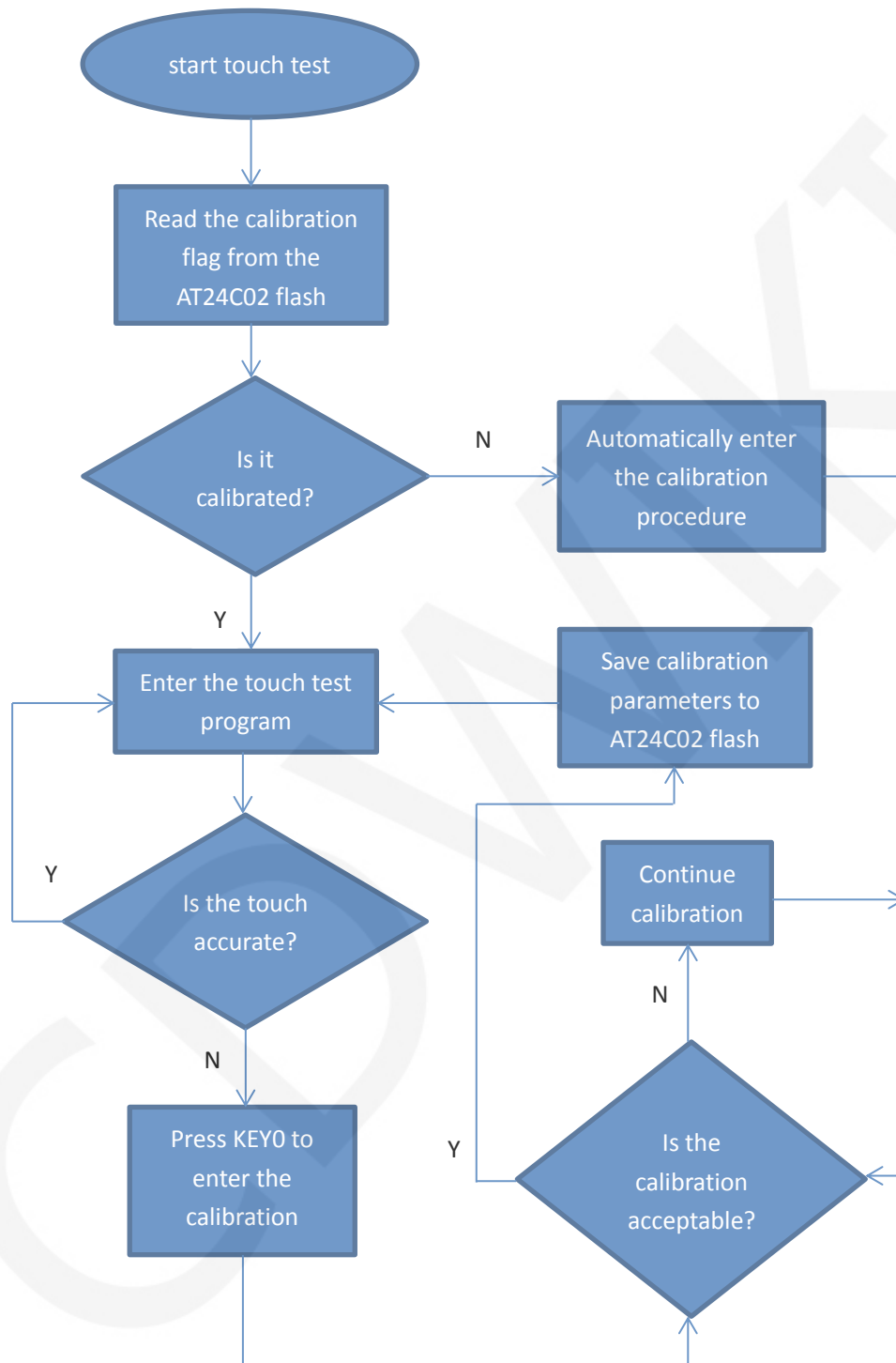

## Common software

This set of test examples requires the display of Chinese and English, symbols and pictures, so the modulo software is used. There are two types of modulo software: Image2Lcd and PCtoLCD2002. Here is only the setting of the modulo software for the test program.

The **PCtoLCD2002** modulo software settings are as follows:

Dot matrix format select **Dark code**

the modulo mode select **the progressive mode**

Take the model to choose **the direction (high position first)**

Output number system selects **hexadecimal number**

Custom format selection **C51 format**

The specific setting method is as follows:

[http://www.lcdwiki.com/Chinese\\_and\\_English\\_display\\_modulo\\_settings](http://www.lcdwiki.com/Chinese_and_English_display_modulo_settings)

Image2Lcd modulo software settings are shown below:



The Image2Lcd software needs to be set to horizontal, left to right, top to bottom, and low position to the front scan mode.